

# Thermal Transfer Printer

***H500B/C/ H400B/ H500E/C /  
H400E Series***

**THERMAL TRANSFER/  
DIRECT THERMAL  
BARCODE PRINTER**

**USER'S MANUAL**

Please keep user manual for reference



## **Copyright Information**

©2016 Zhuhai Hengquan Barcode equipment Co., Ltd.

The copyright in this manual, the software and firmware in the printer described therein are owned by Zhuhai Hengquan Barcode equipment Co., Ltd. All rights reserved.

Information in this document is subject to change without notice and does not represent a commitment on the part of Zhuhai Hengquan Barcode equipment Co., Ltd. No part of this manual may be reproduced or transmitted in any form or by any means, for any purpose other than the purchaser's personal use, without the expressed written permission of Zhuhai Hengquan Barcode equipment Co., Ltd.



## Agency Compliance and Approvals

---



**CE CLASS A**  
**EN 55022**  
**EN 55024**

---



**FCC CFR Title 47 Part 15 Subpart B**  
**ICES-003 Class A**

This device complies with Part 15 of the FCC Rules.  
Operation is subject to the following two conditions.  
(1) This device may not cause harmful interference, and  
(2) This device must accept any interference received,  
including interference that may cause undesired operation.

---



**GB-4953**  
**GB9254 (CLASS A)**  
**GB27625**

---



**IEC 60950-1**

---

# Contents

<b>1. Introduction</b> . . . . .	<b>1</b>
<b>1.1 Product Introduction</b> .....	<b>1</b>
<b>1.2 Product Features</b> .....	<b>2</b>
<b>1.2.1 Printer Standard Features</b> .....	<b>2</b>
<b>1.2.2 Printer Optional Features</b> .....	<b>3</b>
<b>1.3 General Specifications</b> .....	<b>4</b>
<b>1.4 Print Specifications</b> . . . . .	<b>4</b>
<b>1.5 Ribbon Specifications</b> . . . . .	<b>4</b>
<b>1.6 Media Specifications</b> . . . . .	<b>5</b>
<b>2. Operations Overview</b> . . . . .	<b>6</b>
<b>2.1 Unpacking and Inspection</b> .....	<b>6</b>
<b>2.2 Printer Overview</b> .....	<b>7</b>
<b>2.2.1 Front View</b> .....	<b>7</b>
<b>2.2.2 Interior View</b> .....	<b>8</b>
<b>2.2.3 Rear View</b> .....	<b>9</b>
<b>3. Setup</b> . . . . .	<b>10</b>
<b>3.1 Setting up the Printer</b> .....	<b>10</b>
<b>3.2 Loading the Ribbon</b> .....	<b>11</b>
<b>3.3 Loading the Media</b> .....	<b>15</b>
<b>3.3.1 Loading the Roll Labels</b> .....	<b>15</b>
<b>3.3.2 Loading the Media in Peel-off mode (Option)</b> .....	<b>18</b>
<b>3.3.3 Loading the Media in Cutter Mode (Option)</b> .....	<b>20</b>
<b>3.3.4 External Label Roll Mount Installation (Option)</b> .....	<b>21</b>
<b>4. LED and Button Functions</b> . . . . .	<b>23</b>
<b>4.1 LED Indicator</b> .....	<b>23</b>
<b>4.2 Regular Button Functions</b> .....	<b>23</b>
<b>4.3 Power-on Utilities</b> .....	<b>24</b>
<b>4.3.1 Ribbon and Gap/Black Mark Sensor Calibration</b> .....	<b>24</b>
<b>4.3.2 Gap/Black Mark Calibration, Self-test and Dump Mode</b> .....	<b>25</b>
<b>4.3.3 Printer Initialization</b> .....	<b>28</b>
<b>4.3.4 Set Black Mark Sensor as Media Sensor and Calibrate the Black Mark Sensor</b> .....	<b>29</b>
<b>4.3.5 Set Gap Sensor as Media Sensor and Calibrate the Gap Sensor</b> .....	<b>29</b>
<b>4.3.6 Skip AUTO.BAS</b> .....	<b>30</b>
<b>5. Diagnostic Tool</b> . . . . .	<b>31</b>

<b>5.1 Start the Diagnostic Tool .....</b>	<b>31</b>
<b>5.2 Printer Function .....</b>	<b>32</b>
<b>5.3 Calibrating Media Sensor by Diagnostic Tool . . . . .</b>	<b>33</b>
<b>5.3.1 Auto Calibration.....</b>	<b>33</b>
<b>5.4 Setting Ethernet by Diagnostic Utility (Option) . . . . .</b>	<b>34</b>
<b>5.4.1 Using USB interface to setup Ethernet interface.....</b>	<b>34</b>
<b>5.4.2 Using RS-232 interface to setup Ethernet interface .....</b>	<b>35</b>
<b>5.4.3 Using Ethernet interface to setup Ethernet interface.....</b>	<b>36</b>
<b>6. Troubleshooting . . . . .</b>	<b>38</b>
<b>6.1 Common Problems .....</b>	<b>38</b>
<b>7. Maintenance . . . . .</b>	<b>41</b>
<b>Revise History . . . . .</b>	<b>42</b>

# 1. Introduction

## 1.1 Product Introduction

Thank you very much for purchasing ZHUHAI HENGQUAN barcode printer.

The H500B series printer features two durable gear-driven motors that are capable of handling large capacity 300 meter ribbons and large rolls of media inside its sleek design. If the 5" interior label capacity is not enough, simply add an external media roll mount and the H500B can easily handle 8.4" OD rolls of labels designed for expensive industrial label printers.

The moveable sensor design can accept wide range of label media. All of the most frequently used barcode formats are included. Fonts and barcodes can be printed in any one of the four directions.

The H500B series printer is built-in the high quality, high performance MONOTYPE IMAGING® True Type font engine and one CG Triumvirate Bold Condensed smooth font. With flexible firmware design, user can also download the True Type Font from PC into printer memory for printing labels. Besides the scalable font, it also provides a choice of five different sizes of alphanumeric bitmap font, OCR-A and OCR-B fonts. By integrating rich features, it is the most cost-effective and high performance printer in its class!

To print label formats, please refer to the instructions provided with your labeling software; if you need to write the custom programs, please refer to the TSPL/TSPL2 programming manual that can be found on the accessories CD-ROM or on ZHUHAI HENGQUAN website at <http://www.xprinter.net>

- Applications
  - Manufacturing & Warehousing
    - Work in Progress
    - Item Labels
    - Instruction labels
    - Agency labels
  - Healthcare
    - Patient Identification
    - Pharmacy
    - Specimen Identification
  - Parcel Post
    - Shipping/ Receiving Labels
  - Small Office/ Home Office
  - Retail Marking
    - Price tags
    - Shelf labels
    - Jewelry tags

## 1.2 Product Features

### 1.2.1 Printer Standard Features

The printer offers the following standard features.

Product standard feature	203 dpi models	300 dpi models
Thermal transfer printing	<input type="radio"/>	<input type="radio"/>
Direct thermal printing	<input type="radio"/>	<input type="radio"/>
ABS plastic enclosure	<input type="radio"/>	<input type="radio"/>
Position adjustable gap sensor	<input type="radio"/>	<input type="radio"/>
Position adjustable black mark sensor	<input type="radio"/>	<input type="radio"/>
Ribbon sensor	<input type="radio"/>	<input type="radio"/>
Head open sensor	<input type="radio"/>	<input type="radio"/>
USB 2.0 (full speed) interface	<input type="radio"/>	<input type="radio"/>
8 MB SDRAM memory	<input type="radio"/>	<input type="radio"/>
4 MB FLASH memory	<input type="radio"/>	<input type="radio"/>
microSD memory card reader for memory expansion up to 4 GB	<input type="radio"/>	<input type="radio"/>
Real time clock	<input type="radio"/>	<input type="radio"/>
One power switch, one feed button and LED	<input type="radio"/>	<input type="radio"/>
Standard industry emulations right out of the box including Eltron® and Zebra® language support	<input type="radio"/>	<input type="radio"/>
Internal 8 alpha-numeric bitmap fonts	<input type="radio"/>	<input type="radio"/>
Fonts and barcodes can be printed in any one of the four directions (0, 90,180, 270 degree)	<input type="radio"/>	<input type="radio"/>
Internal Monotype Imaging® true type font engine with one CG Triumvirate Bold Condensed scalable font	<input type="radio"/>	<input type="radio"/>
Downloadable fonts from PC to printer memory	<input type="radio"/>	<input type="radio"/>
Downloadable firmware upgrades	<input type="radio"/>	<input type="radio"/>
Text, barcode, graphics/image printing (Please refer to the TSPL/TSPL2 programming manual for supporting code page)	<input type="radio"/>	<input type="radio"/>

Supported bar code		Supported image
1D bar code	2D bar code	
Code 39, Code 93, Code128UCC, Code128 subsets A,B,C, Codabar, Interleaved 2 of 5, EAN-8, EAN-13, EAN-128, UPC-A, UPC-E, EAN and UPC 2(5) digits add-on, MSI, PLESSEY, POSTNET, China POST, GS1 DataBar, Code 11	PDF-417, Maxicode, DataMatrix, QR code, Aztec, GS1 DataBar Composite code	BITMAP, BMP, PCX (Max. 256 colors graphics)

## 1.2.2 Printer Optional Features

The printer offers the following optional features.

Product option feature	User options	Dealer options	Factory options
LCD display (graphic type, 128x64 pixel) with back light	-	-	-
Internal Ethernet print server (10/100 Mbps) interface	-	-	○
Serial RS-232C (2400-115200 bps) interface	-	-	○
Centronics interface	-	-	○
Peel-off module	-	○	○
Guillotine cutter module (Full cut and partial cut) Paper thickness: 0.06~ 0.19mm, 500,000 cuts 0.20~ 0.25mm, 200,000 cuts	-	○	○
<b>Note:</b> <b>Except for the linerless cutter, all regular/heavy duty/care label cutters DO NOT cut on media with glue.</b>			
<u>External roll mount with 3" core (8.4 OD) label spindle</u>	○		
Extended plate for external roll mount	○		
Bluetooth module (RS-232C interface)	-	-	○

## 1.3 General Specifications

<b>General Specifications</b>	
Physical dimensions	300 mm (D) x 230 mm (W) x 194 mm (H)
Weight	2.47 kg
Electrical	External universal switching power supply Input: AC 100-240V Output: DC 24V 2.5A, 60W
Environmental condition	Operation: 5 ~ 40°C (41 ~ 104°F), 25~85% non-condensing Storage: -40 ~ 60 °C (-40 ~ 140° F), 10~90% non-condensing

## 1.4 Print Specifications

<b>Print Specifications</b>	<b>203 dpi models</b>	<b>300 dpi models</b>
Print head resolution	203 dots/inch (8 dots/mm)	300 dots/inch (12 dots/mm)
Printing method	Thermal transfer and direct thermal	
Dot size (width x length)	0.125 x 0.125 mm (1 mm = 8 dots)	0.084 x 0.084 mm (1 mm = 11.8 dots)
Print speed (inches per second)	H500B: 2, 3, 4, 5 ips H400B: 2, 3, 4, 5 ips	H500E: 1.5, 2, 3, 4 ips H400E: 1.5, 2, 3, 4 ips
Print speed for peel mode & cutter mode	2, 3 ips	
Max. print width	108 mm (4.25")	104 mm (4.09")
Max. print length	2,794 mm (110")	1,016 mm (40")

## 1.5 Ribbon Specifications

<b>Ribbon Specifications</b>	
Ribbon outside diameter	Max. 67 mm
Ribbon length	300 meter
Ribbon core inside diameter	1 inch (25.4 mm)
Ribbon width	Max. 110 mm
	Min. 40 mm
Ribbon wound type	Outside wound

## 1.6 Media Specifications

Media Specifications	203 dpi models	300 dpi models
Label roll capacity	127 mm (5") OD	
Media type	Continuous, die-cut, black mark, fan-fold, notch	
Media wound type	Printing face outside wound & Printing face inside wound	
Media width (label + liner)	Max. 118 mm (4.6")	
	Min. 25.4 mm (1.0")	
Media thickness (label + liner)	Max. 0.254 mm (10 mil)	
	Min. 0.06 mm (2.36 mil)	
Media core diameter	25.4 mm~38 mm (1"~1.5")	
Label length	10~2,794 mm (0.39"~110")	10~1,016 mm (0.39"~40")
	Note: If your label length is less than 25.4mm (1"), we recommend you to use the perforation at the gap for easier tear away.	
Label length (peeler mode)	Max. 152.4 mm (6")	
	Min. 25.4 mm (1")	
Label length (cutter mode)	Max. 2,794 mm (110")	Max. 1,016 mm (40")
	Min. 25.4 mm (1")	Min. 25.4 mm (1")
Gap height	Min. 2 mm (0.09")	
Black mark height	Min. 2 mm (0.09")	
Black mark width	Min. 8 mm (0.31")	

## 2. Operations Overview

### 2.1 Unpacking and Inspection

This printer has been specially packaged to withstand damage during shipping. Please carefully inspect the packaging and printer upon receiving the barcode printer. Please retain the packaging materials in case you need to reship the printer.

Unpacking the printer, the following items are included in the carton.

- One printer unit
- One Windows labeling software/Windows driver CD disk
- One quick installation guide
- One power cord
- One auto switching power supply
- One USB interface cable
- Two ribbon spindle
- One ribbon paper core
- One label spindle

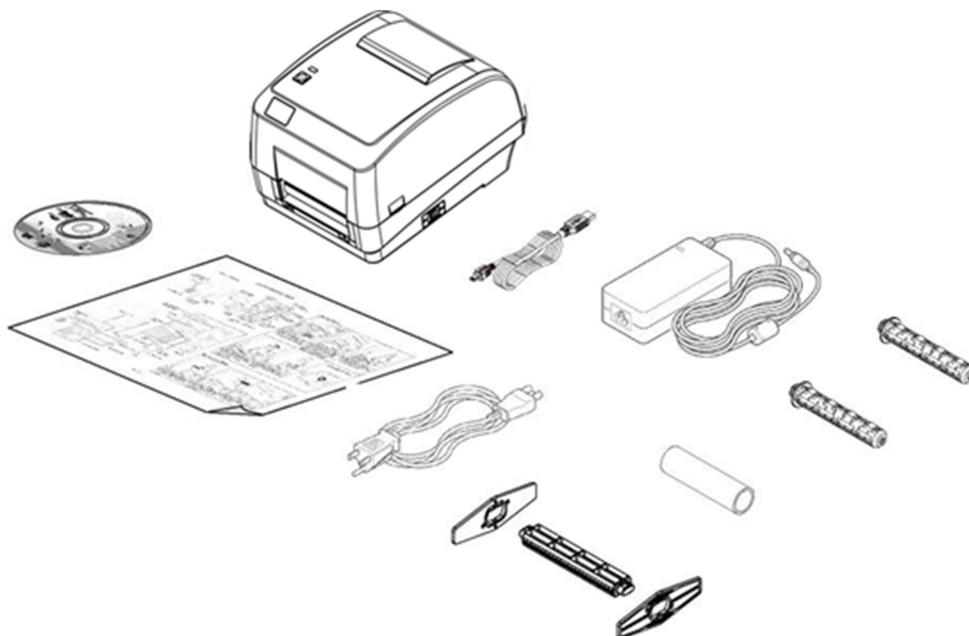

If any parts are missing, please contact the Customer Service Department of your purchased reseller or distributor.

## 2.2 Printer Overview

### 2.2.1 Front View



1. LED indicator
2. Feed key
3. Paper exit chute
4. Power switch
5. Top cover open tab

## 2.2.2 Interior View

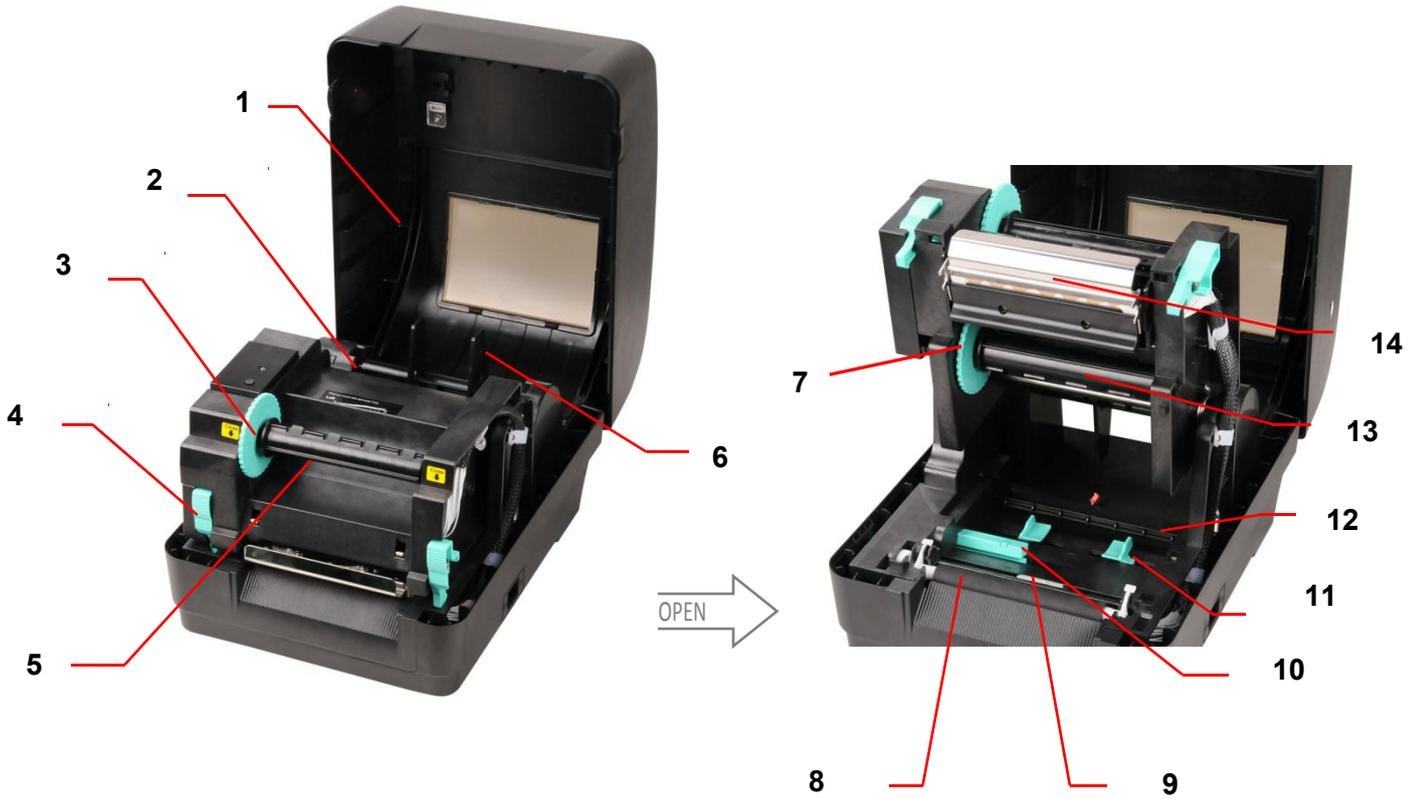

1. Printer top cover
2. Media supply spindle
3. Ribbon rewind hub
4. Print head release button
5. Ribbon rewind spindle
6. Fixing tab
7. Ribbon supply hub
8. Platen roller
9. Black mark sensor
10. Gap sensor
11. Media guide
12. Media bar
13. Ribbon supply spindle
14. Print head

### 2.2.3 Rear View

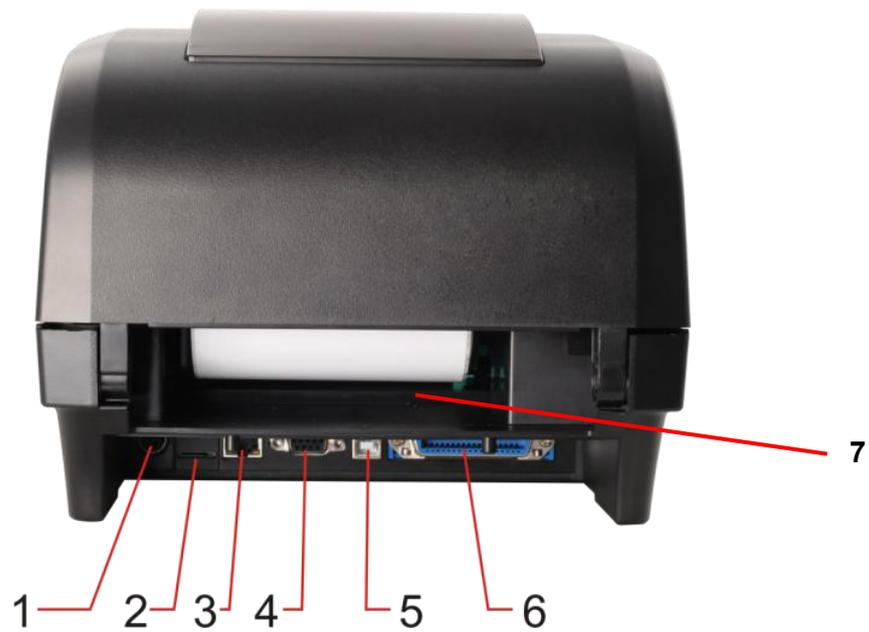

1. Power jack socket
2. \*microSD card slot
3. Internal Ethernet interface (Option)
4. RS-232C interface (Option)
5. USB interface (USB 2.0/ Full speed mode)
6. Centronics interface (Option)
7. Rear external label entrance chute

**Note:**

The interface picture here is for reference only. Please refer to the product specification for the interfaces availability.

## 3. Setup

### 3.1 Setting up the Printer

1. Place the printer on a flat, secure surface.
2. Make sure the power switch is off.
3. Connect the printer to the computer with the provided USB cable.
4. Plug the power cord into the AC power cord socket at the rear of the printer, and then plug the power cord into a properly grounded power outlet.

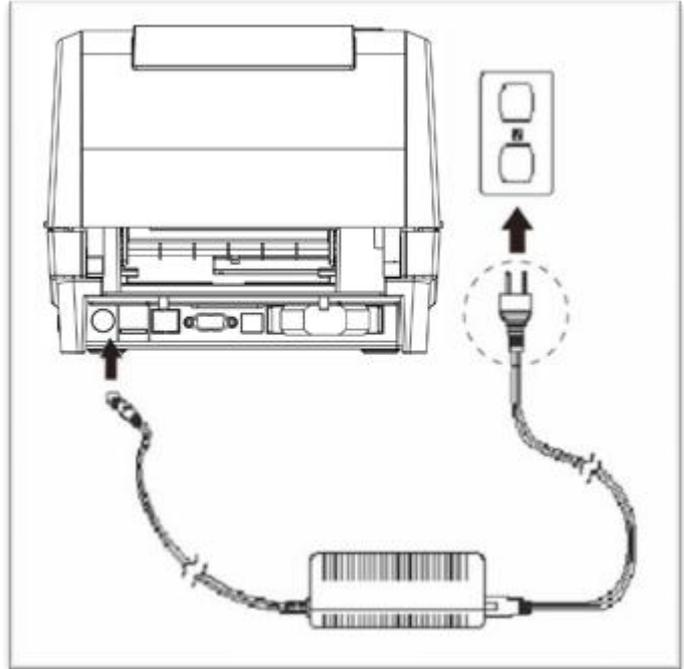

**Note:**

- \* Please switch OFF printer power switch prior to plug in the power cord to printer power jack.
- \* The interface picture here is for reference only. Please refer to the product specification for the interfaces availability.

## 3.2 Loading the Ribbon



1. Open the printer top cover by pressing the top cover open tabs located on each side of the printer.



2. Insert the paper core to the ribbon rewind spindle.



3. Insert the left side of ribbon rewind spindle to the ribbon rewind hub first then insert the right side of ribbon rewind spindle to the hole at the right side of ribbon mechanism.

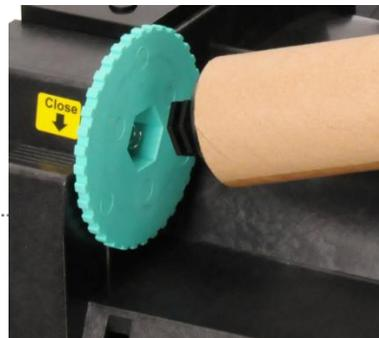

4. Push the print head release button to open the print head mechanism.



5. Insert the ribbon to the ribbon spindle.



6. Insert the left side of ribbon supply spindle to the ribbon supply hub first then insert the right side of ribbon supply spindle to the hole at the right side of ribbon mechanism.





7. Pull the leader of the ribbon through the print head and stick the leader of the ribbon onto the ribbon rewind paper core.

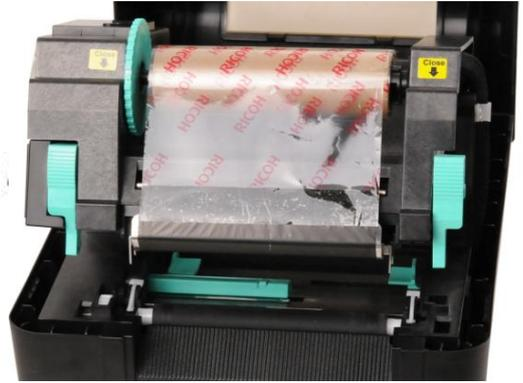

8. Turn the ribbon rewind hub until the ribbon plastic leader is thoroughly wound and the black section of the ribbon covers the print head.

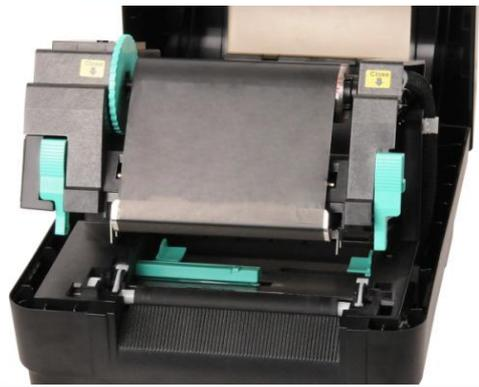

9. Close the print head mechanism by both hands and make sure the latches are engaged securely.



- **Ribbon loading path**

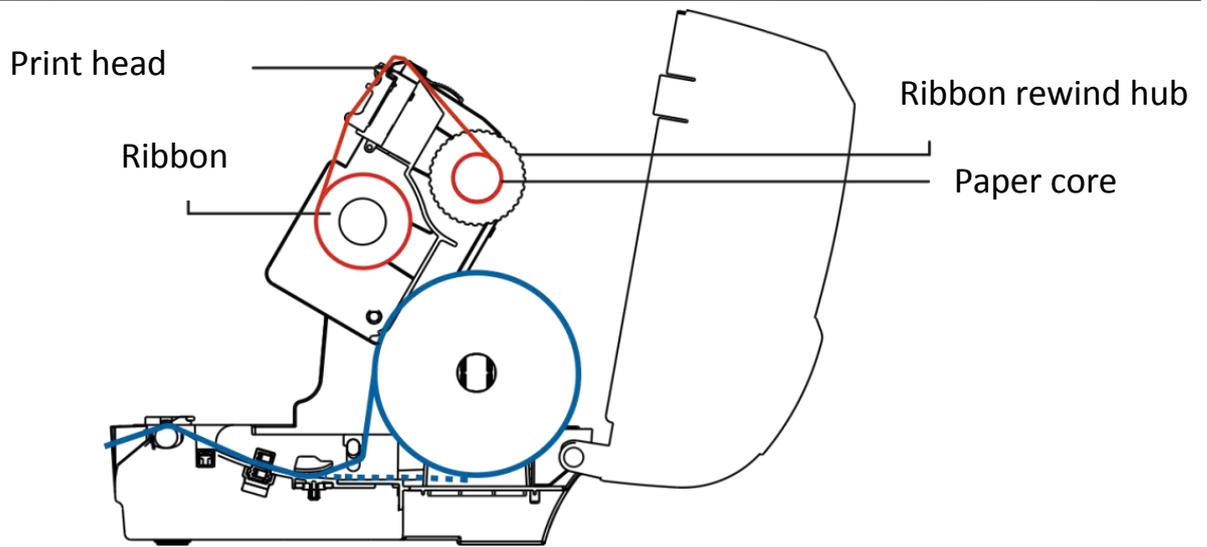

## 3.3 Loading the Media

### 3.3.1 Loading the Roll Labels



1. Open the printer top cover by pressing the top cover open tabs located on each side of the printer.



2. Insert the paper roll into the media supply spindle and use two fixing tabs to fix the paper roll onto the center of the spindle. (If your paper width is 4 inch, you can remove the fixing tabs from the supply spindle.)



3. Place the paper roll onto the paper roll mount.



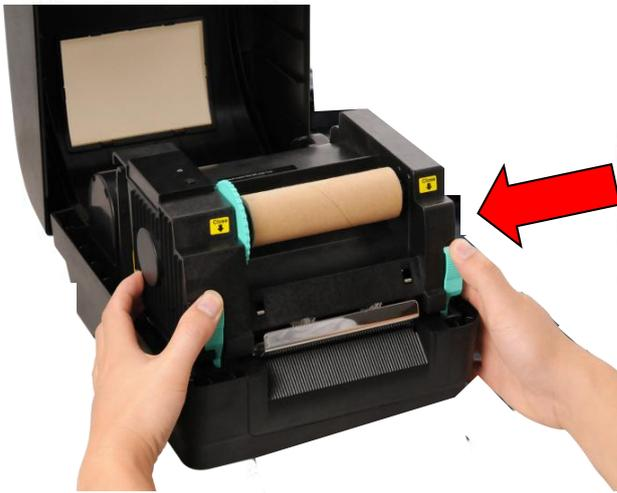

4. Push the print head release button to open the print head mechanism.

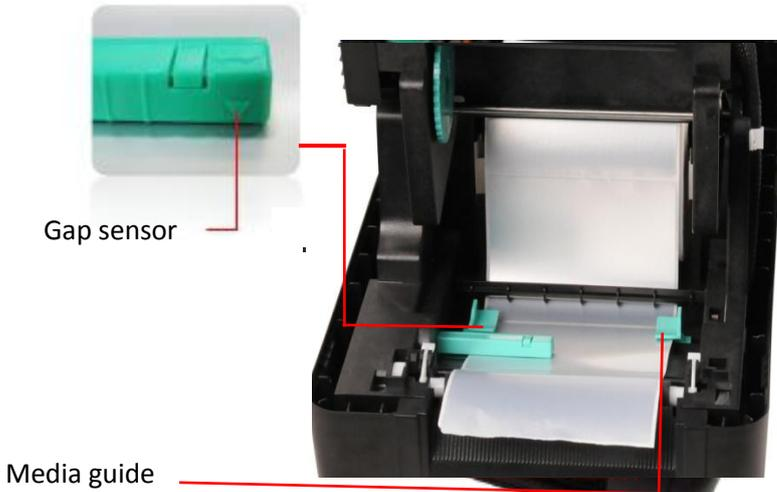

5. Feed the paper, printing side face up, through the media bar, media sensor and place the label leading edge onto the platen roller. Move the media guides to fit the label width.

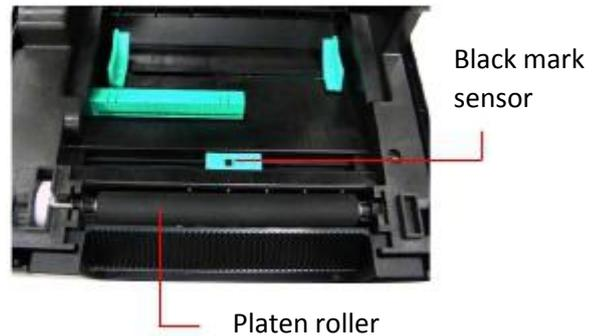

**Note: The media sensor position is moveable. Please make sure the gap or black mark is at the location where media gap/black mark will pass through for sensing.**

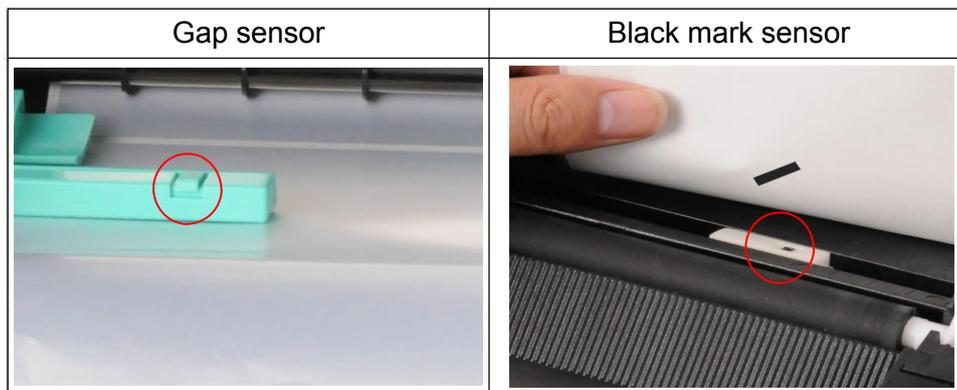

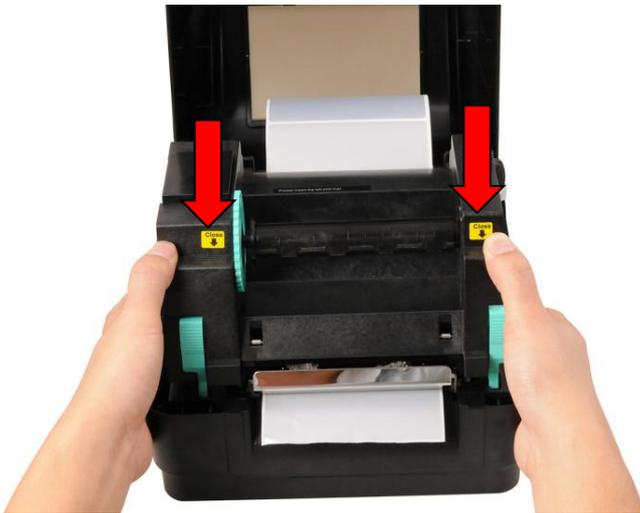

6. Close the print head mechanism by both hands and make sure the latches are engaged securely.

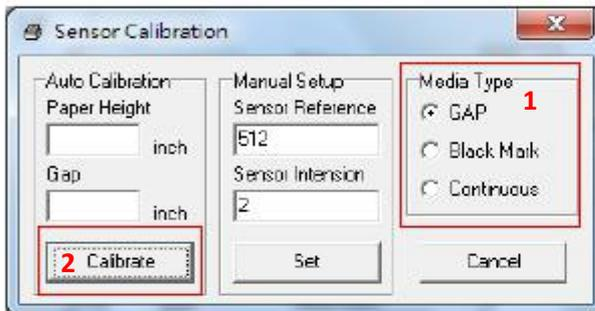

7. Use "Diagnostic Tool" to set the media sensor type and calibrate the selected sensor. (Start the "Diagnostic tool" → Select the "Printer Configuration" tab → Click the "Calibrate Sensor" button ) Please refer to section 5.3.

- **Media loading path**

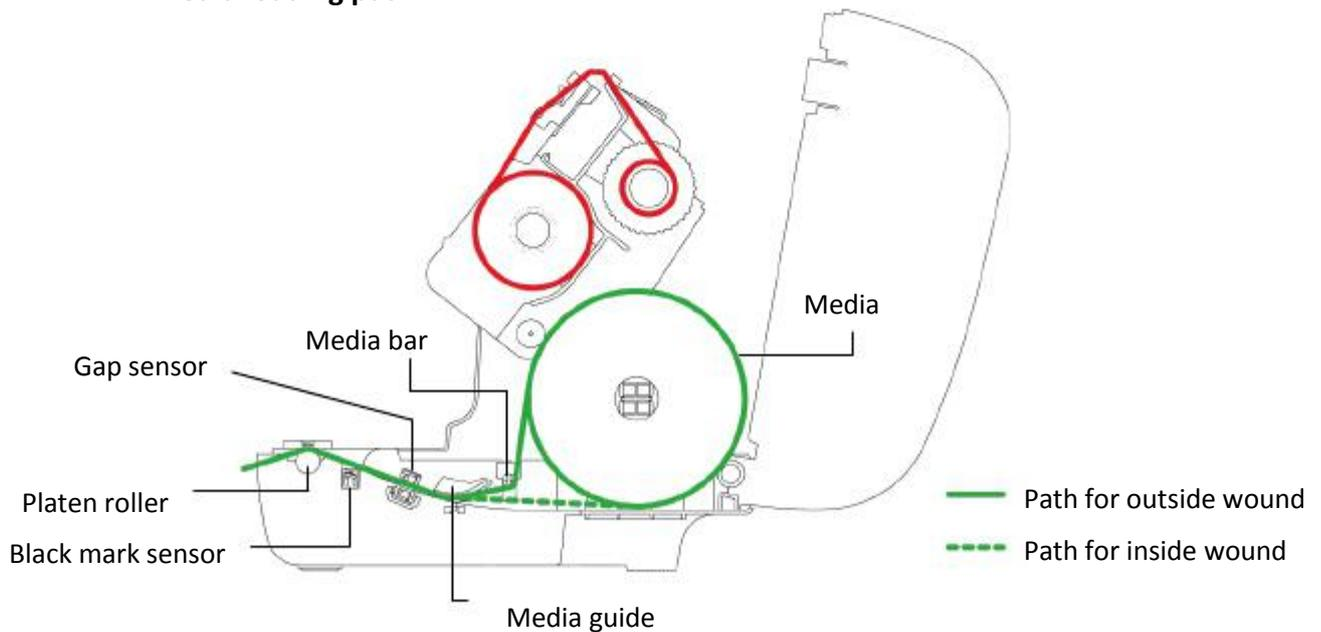

### 3.3.2 Loading the Media in Peel-off mode (Option)

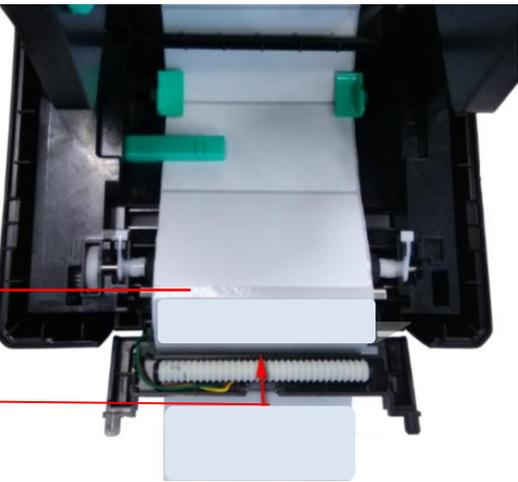
	<ol style="list-style-type: none"><li>1. Refer to chapter 3.3.1 to install the label. Use “Diagnostic Tool” to set the media sensor type and calibrate the selected sensor.</li></ol>
 <p>Liner Label</p>	<ol style="list-style-type: none"><li>2. Pull the label through the front of the printer and take some labels off only leave the liner.</li></ol>
 <p>Liner Peel-off Cover slot</p>	<ol style="list-style-type: none"><li>3. Open the peel-off cover. Feed the liner into peel-off cover slot.</li></ol>

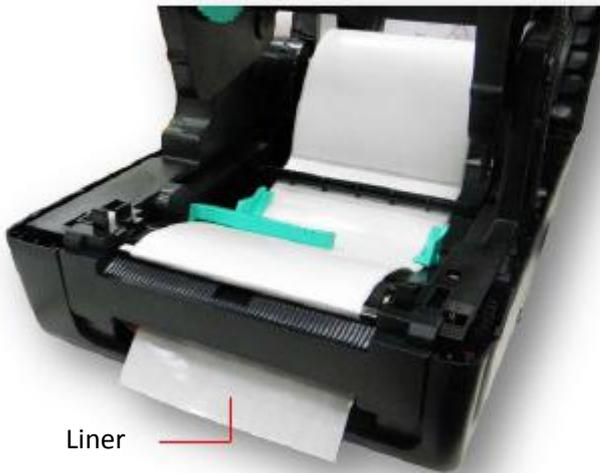

Liner

4. Close the peel-off module. Use the DiagTool to set the peel-off mode by selecting "PEEL" option for Post-Print Action setting then click "Set" button to enable the peel-off mode.

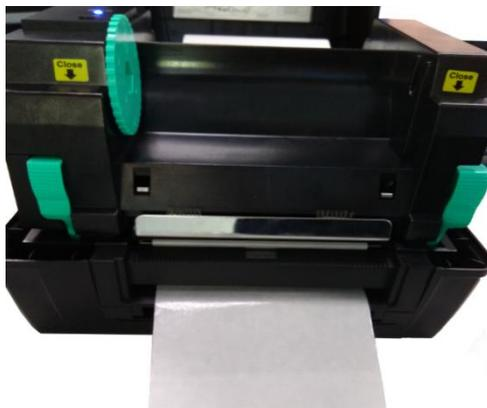
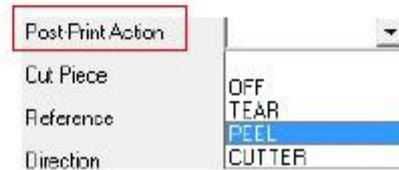

5. Close the print head mechanism and printer cover. Printer is ready for peel-off mode.

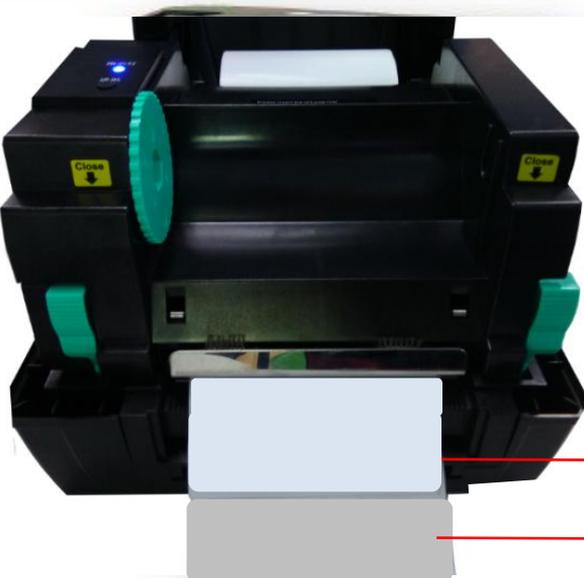

Label

Liner

6. Press the FEED button to test.

**Note:**

Please calibrate the gap/black mark sensor when changing media.

### 3.3.3 Loading the Media in Cutter Mode (Option)

	<p>1. Refer to chapter 3.3.1 to install the label.</p>
	<p>2. Lead the media through the cutter paper opening.</p>
 	<p>3. Close the print head mechanism and printer cover. Use the DiagTool to set the printer for cutter mode by selecting "CUTTER" option for Post-Print Action setting then click "Set" button to enable the cutter mode. Press the FEED button to test.</p>

**Note:**  
Please calibrate the gap/black mark sensor when changing media.

### 3.3.4 External Label Roll Mount Installation (Option)



1. Use two screws to install the extended plate onto the external label roll mount.

External label  
Roll mount

Extended  
plate

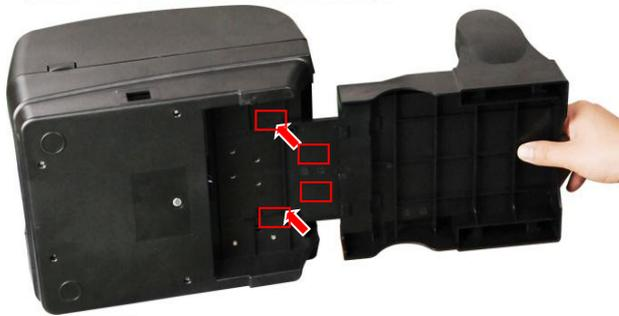

2. Attach the extended plate on the bottom of the printer. (If you purchase the external label roll mount only, just need to put it on the rear of printer for using.)



3. Insert a 3" (or 1") label spindle into a paper roll. And install it on the external paper roll mount.



4. Feed the media through the rear external label entrance chute.



5. Refer to chapter 3.3.1 to install the label. Use "Diagnostic Tool" to set the media sensor type and calibrate the selected sensor.

---

**Note:**

**Please calibrate the gap/black mark sensor when changing media.**

---

## 4. LED and Button Functions

This printer has one button and one three-color LED indicator. By indicating the LED with different color and pressing the button, printer can feed labels, pause the printing job, select and calibrate the media sensor, print printer self-test report, reset printer to defaults (initialization). Please refer to the button operation below for different functions.

### 4.1 LED Indicator

LED Color	Description
Blue/ Solid	This illuminates that the power is on and the device is ready to use.
Blue / Flash	This illuminates that the system is downloading data from PC to memory or the printer is paused.
Purple	This illuminates that the system is clearing data from printer.
Red / Solid	This illuminates printer head open, cutter error.
Red / Flash	This illuminates a printing error, such as head open, paper empty, paper jam, ribbon empty, or memory error etc.

### 4.2 Regular Button Functions

#### 1. Feed labels

When the printer is at ready states (Blue/ Solid), press the button to feed one label to the beginning of next.

#### 2. Pause the printing job

When the printer is at printing states, press the button to pause a print job. When the printer is paused the LED will be blue blinking. Press the button again to continue the printing job.

## 4.3 Power-on Utilities

There are six power-on utilities to set up and test printer hardware. These utilities are activated by pressing FEED button then turning on the printer power simultaneously and release the button at different color of LED.

Please follow the steps below for different power-on utilities.

1. Turn off the printer power switch.
2. Hold on the button then turn on the power switch.
3. Release the button when LED indicates with different color for different functions.

<i>Power on utilities</i>	<b>The LED color will be changed as following pattern:</b>						
<i>LED color</i>	Amber	Red (5 blinks)	Amber (5 blinks)	Green (5 blinks)	Green/Amber (5 blinks)	Red/Amber (5 blinks)	Solid green
<i>Functions</i>							
<b>1. Ribbon sensor calibration and gap / black mark sensor calibration</b>		<i>Release</i>					
<b>2. Gap / black mark sensor calibration, Self-test and enter dump mode</b>			<i>Release</i>				
<b>3. Printer initialization</b>				<i>Release</i>			
<b>4. Set black mark sensor as media sensor and calibrate the black mark sensor</b>					<i>Release</i>		
<b>5. Set gap sensor as media sensor and calibrate the gap sensor</b>						<i>Release</i>	
<b>6. Skip AUTO.BAS</b>							<i>Release</i>

### 4.3.1 Ribbon and Gap/Black Mark Sensor Calibration

Gap/black mark sensor sensitivity should be calibrated at the following conditions:

1. A brand new printer
2. Change label stock
3. Printer initialization

Please follow the steps below to calibrate the ribbon and gap/black mark sensor.

1. Turn off the power switch.
2. Hold on the button then turn on the power switch.
3. Release the button when LED becomes **red** and blinking. (Any red will do during the 5 blinks).

- It will calibrate the ribbon sensor and gap/black mark sensor sensitivity.

- The LED color will be changed as following order :  
Purple → **red (5 blinks)** → purple (5 blinks) → blue (5 blinks) → blue/purple (5 blinks)  
→ red/purple (5 blinks) → solid blue

**Note:**

Please select gap or black mark sensor by sending **GAP** or **BLINE** command to printer prior to calibrate the sensor.

For more information about **GAP** and **BLINE** command, please refer to **TSPL2 programming manual**.

### 4.3.2 Gap/Black Mark Calibration, Self-test and Dump Mode

While calibrate the gap/black mark sensor, printer will measure the label length, print the internal configuration (self-test) on label and then enter the dump mode. To calibrate gap or black mark sensor, depends on the sensor setting in the last print job.

Please follow the steps below to calibrate the sensor.

1. Turn off the power switch.
2. Hold on the button then turn on the power switch.
3. Release the button when LED becomes **purple** and blinking. (Any purple will do during the 5 blinks)

- The LED color will be changed as following order.  
Purple → red (5 blinks) → **purple (5 blinks)** → blue (5 blinks) → blue/purple (5 blinks)  
→ red/purple (5 blinks) → solid blue

4. It calibrates the sensor and measures the label length and prints internal settings then enter the dump mode.

**Note:**

Please select gap or black mark sensor by **Diagnostic Tool** or by **GAP** or **BLINE** command prior to calibrate the sensor.

For more information about **GAP** and **BLINE** command, please refer to **TSPL2 programming manual**.

## ■ Self-test

Printer will print the printer configuration after gap/black mark sensor calibration. Self-test printout can be used to check if there is any dot damage on the heater element, printer configurations and available memory space.

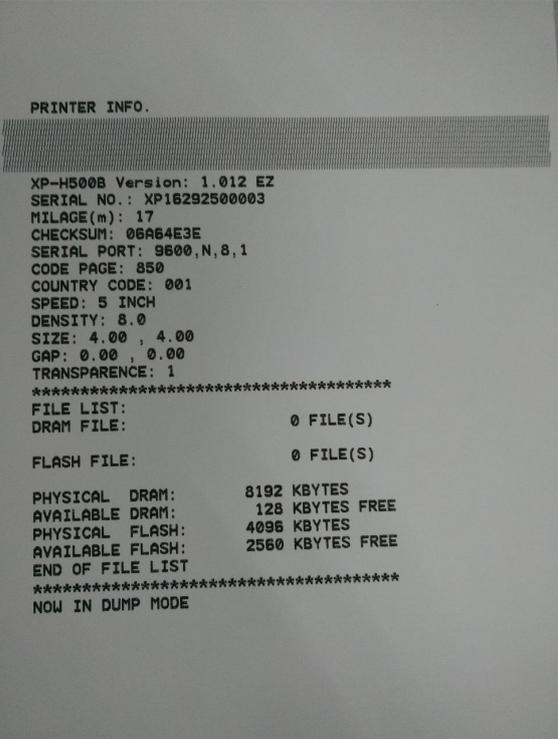
Self-test printout	
	<p>Printer model name &amp; Main board firmware version</p> <p>Printer serial number</p> <p>Printed mileage</p> <p>Main board firmware checksum</p> <p>Serial port setting</p> <p>Code page</p> <p>Country code</p> <p>Print speed</p> <p>Print darkness</p> <p>Label size (width, height)</p> <p>Black mark or gap size (vertical gap, offset)</p> <p>Sensor sensitivity</p> <p>File management information</p>

```
CODE PAGE: 850
COUNTRY CODE: 001
SPEED: 5 INCH
DENSITY: 8.0
SIZE: 4.00 , 4.00
GAP: 0.00 , 0.00
TRANSPARENCE: 1
```

Print speed (inch/sec)  
Print darkness  
Label size (inch)  
Gap distance (inch)  
Gap/black mark sensor intension  
Code page  
Country code

```
SERIAL PORT: 9600,N,8,1
```

RS232 serial port  
configuration

```
*****
FILE LIST:
DRAM FILE:          0 FILE(S)

FLASH FILE:         0 FILE(S)

PHYSICAL DRAM:      8192 KBYTES
AVAILABLE DRAM:     128 KBYTES FREI
PHYSICAL FLASH:     4096 KBYTES
AVAILABLE FLASH:    2560 KBYTES FREI
END OF FILE LIST
*****
```

Numbers of download files  
Total & available memory  
space

## ■ Dump mode

Printer will enter dump mode after printing printer configuration. In the dump mode, all characters will be printed in 2 columns as following. The left side characters are received from your system and right side data are the corresponding hexadecimal value of the characters. It allows users or engineers to verify and debug the program.

ASCII Data

```

mm GRP 4 mm 00 00 00 00 47 41 50 20 34 20 60 60
0 mm SET 2C 20 30 20 60 60 60 60 60 53 45 54 20
RIBBON OFF 52 40 42 42 4F 4E 20 4F 4E 4E 60 00
DIRECTION 0, 44 40 52 45 43 54 40 4F 4E 20 30 2C
0 REFERENCE 30 00 00 52 45 46 46 52 45 46 43 45
0 0 OFFSET 20 30 2C 30 00 0A 4F 4E 46 53 45 54
0 mm SET P 20 30 20 60 60 00 0A 53 45 54 20 50
REL OFF SET 45 45 4C 20 4F 4E 46 00 0A 53 45 54
CUTTER OFF 20 43 55 54 54 45 52 20 4F 4E 46 00
SET TEAR ON 0A 53 45 54 20 54 45 41 52 20 4F 4E
CLS BAR 2 00 0A 43 4C 53 00 0A 42 41 52 20 32
02, 010, 400, 30 32 2C 30 31 30 2C 20 34 30 30 2C
2 BAR 203, 20 32 00 0A 42 41 52 20 32 30 33 2C
600, 2, 203 30 30 30 2C 20 32 2C 20 32 30 33 00
BAR 202,600 0A 42 41 52 20 32 30 32 2C 30 30 30 30
, 400, 2, BA 2C 20 34 30 36 2C 20 32 00 0A 42 41
R 607,600, 2 52 20 36 30 37 2C 30 30 36 2C 20 32
, 203 BAR 2 2C 20 32 30 33 00 0A 42 41 52 20 32
00, 004, 304, 30 30 2C 30 30 34 2C 20 33 30 34 2C
2 BAR 200, 20 32 00 0A 42 41 52 20 32 30 39 2C
614, 2, 191 30 31 34 2C 20 32 2C 20 31 39 31 00
BAR 200,615 0A 42 41 52 20 32 30 30 2C 30 31 35
, 394, 2 BA 2C 20 33 30 34 2C 20 32 00 0A 42 41
R 601,614, 2 52 20 30 31 2C 30 31 34 2C 20 32
191 BAR 5 2C 20 31 39 31 00 0A 42 41 52 20 35
00,761, 82, 30 36 2C 37 36 31 2C 20 30 32 2C 20
10 BAR 543, 31 30 00 0A 42 41 52 20 35 34 33 2C
649, 10, 121 30 34 30 2C 20 31 30 2C 20 31 32 31
BAR 415,76 00 0A 42 41 52 20 34 31 35 2C 37 36
1, 71, 10 0 31 2C 20 37 31 2C 20 31 30 00 0A 42
AR 425,705, 41 52 20 34 32 35 2C 37 30 35 2C 20
81, 11 BAR 30 31 2C 20 31 31 00 0A 42 41 52 20
415,650, 71, 34 31 35 2C 36 35 30 2C 20 37 31 2C
10 BAR 477 20 31 30 00 0A 42 41 52 20 34 37 37
,649, 10, 12 2C 36 34 39 2C 20 31 30 2C 20 31 32
1 BAR 324,7 31 00 0A 42 41 52 20 33 32 34 2C 37
81, 71, 10 30 31 2C 20 37 31 2C 20 31 30 00 0A
BAR 324,705, 42 41 52 20 33 32 34 2C 37 30 35 2C
71, 11 BAR 20 37 31 2C 20 31 31 00 0A 42 41 52
324,650, 71 20 33 32 34 2C 36 35 30 2C 20 37 31
, 10 BAR 38 2C 20 31 30 00 0A 42 41 52 20 33 38
6,704, 10, 6 30 2C 37 30 34 2C 20 31 30 2C 20 36
6 BAR 325,6 30 00 0A 42 41 52 20 33 32 35 2C 36
49, 10, 66 34 39 2C 20 31 30 2C 20 36 36 00 0A
BAR 222,761, 42 41 52 20 32 32 32 2C 37 36 31 2C
81, 10 BAR 20 30 31 2C 20 31 30 00 0A 42 41 52
259,649, 10 20 32 35 39 2C 36 34 39 2C 20 31 30
, 121 PRINT 2C 20 31 32 31 00 0A 50 52 49 4E 54
1, 1 20 31 2C 31 00 0A

```

Hex decimal data related to left column of ASCII data

### Note:

1. Dump mode requires 4" wide paper width.
2. Turn off / on the power to resume printer for normal printing.

### 4.3.3 Printer Initialization

Printer initialization is used to clear DRAM and restore printer settings to defaults. The only one exception is ribbon sensitivity, which will not be restored to default.

Printer initialization is activated by the following procedures.

1. Turn off the power switch.
2. Hold on the button then turn on the power switch.
3. Release the button when LED turns **blue** after 5 purple blinks. (Any blue will do during the 5 blinks).

### ■ The LED color will be changed as following:

Purple → red (5 blinks) → purple (5 blinks) → **blue (5 blinks)** → blue/purple (5 blinks) → red/purple (5 blinks) → solid blue

Printer configuration will be restored to defaults as below after initialization.

Parameter	Default setting
Speed	101.6 mm/sec (4 ips) (203DPI) 76 mm/sec (3 ips) (300DPI)
Density	8
Label Width	4" (101.5 mm)
Label Height	4" (101.5 mm)
Sensor Type	Gap sensor
Gap Setting	0.12" (3.0 mm)
Print Direction	0
Reference Point	0,0 (upper left corner)
Offset	0
Tear Mode	On
Peel off Mode	Off
Cutter Mode	Off
Serial Port Settings	9600 bps, none parity, 8 data bits, 1 stop bit
Code Page	850
Country Code	001
Clear Flash Memory	No
IP Address	DHCP

#### 4.3.4 Set Black Mark Sensor as Media Sensor and Calibrate the Black Mark Sensor

Please follow the steps as below.

1. Turn off the power switch.
2. Hold on the button then turn on the power switch.
3. Release the button when LED turns **blue/purple** after 5 blue blinks. (Any blue/purple will do during the 5 blinks).

- The LED color will be changed as following:  
Purple → red (5 blinks) → purple (5 blinks) → blue (5 blinks) → **blue/purple (5 blinks)**  
→ red/purple (5 blinks) → solid blue

#### 4.3.5 Set Gap Sensor as Media Sensor and Calibrate the Gap Sensor

Please follow the steps as below.

1. Turn off the power switch.
2. Hold on the button then turn on the power switch.

3. Release the button when LED turns **red/purple** after 5 blue/purple blinks. (Any red/purple will do during the 5 blinks).

- The LED color will be changed as following:  
Purple → red (5 blinks)→ purple (5 blinks) → blue (5 blinks) → blue/purple (5 blinks) → **red/purple (5 blinks)** → solid blue

#### 4.3.6 Skip AUTO.BAS

TSPL2 programming language allows user to download an auto execution file to flash memory. Printer will run the AUTO.BAS program immediately when turning on printer power. The AUTO.BAS program can be interrupted without running the program by the power-on utility.

Please follow the procedures below to skip an AUTO.BAS program.

1. Turn off printer power.
2. Press the FEED button and then turn on power.
3. Release the FEED button when LED becomes **solid blue**.

- The LED color will be changed as following:  
Purple → red (5 blinks)→ purple (5 blinks) → blue (5 blinks) → blue/purple (5 blinks) → red/purple (5 blinks) → **solid blue**

4. Printer will be interrupted to run the AUTO.BAS program.

## 5. Diagnostic Tool

ZHUHAI HENGQUAN's Diagnostic Utility is an integrated tool incorporating features that enable you to explore

a printer's settings/status; change a printer's settings; download graphics, fonts and firmware; create a printer bitmap font; and send additional commands to a printer. With the aid of this powerful tool, you can review printer status and settings in an instant, which makes it much easier to troubleshoot problems and other issues.

### 5.1 Start the Diagnostic Tool



1. Double click on the Diagnostic tool icon to start the software.
2. There are four features (Printer Configuration, File Manager, Bitmap Font Manager, Command Tool) included in the Diagnostic utility.

**Printer Status**

**Interface**

**Features tab**

**Printer functions**

**Printer Status**

**Interface**

**Printer setup**

COM1 9600,N,8,1 | LPT1 | MAC:8c-f2-28-03-16-1a IP:192.168.192.168 | USB001 Model Name:XPINTERXP-H500B | 2016/12/2 下午 04:05:38

## 5.2 Printer Function

1. Select the PC interface connected with barcode printer.

The default interface setting is USB interface. If USB interface is connected with printer, no other settings need to be changed in the interface field.

2. Click the “Printer Function” button to setup.
3. The detail functions in the Printer Function Group are listed as below.

Printer Function	Function	Description
Calibrate Sensor	Calibrate Sensor	Calibrate the sensor specified in the Printer Setup group media sensor field
Ethernet Setup	Ethernet Setup	Setup the IP address, subnet mask, gateway for the on board Ethernet
RTC Setup	RTC Setup	Synchronize printer Real Time Clock with PC
Factory Default	Print Test Page	Print a test page
Reset Printer	Reset Printer	Reboot printer
Print TestPage	Factory Default	Initialize the printer and restore the settings to factory default. (Please refer section 4.3.3)
Configuration Page	Dump Text	To activate the printer dump mode.
Dump Text	Ignore AUTO.BAS	Ignore the downloaded AUTO.BAS program
Ignore AUTO.BAS	Configuration Page	Print printer configuration (Please refer section 4.3.2)
Password Setup	Password Setup	Set the password to protect the settings
Exit Line Setup		

## 5.3 Calibrating Media Sensor by Diagnostic Tool

### 5.3.1 Auto Calibration

1. Make sure the media is install ready and print head mechanism is closed. (Please refer to section 3.3.)

**Note: The media sensor position is moveable. Please make sure the gap (▽) or black mark is at the location where media gap/black mark will pass through for sensing.**

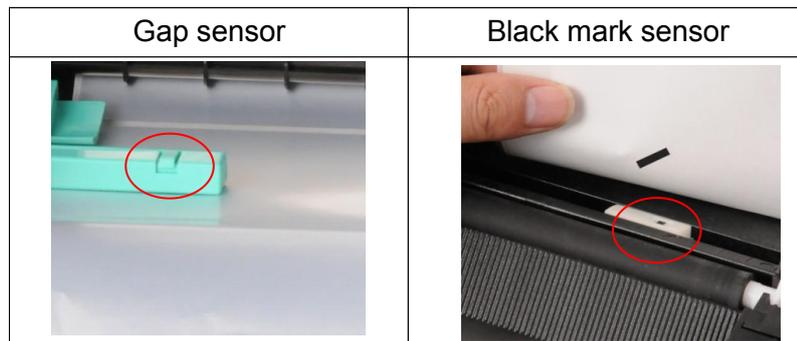

2. Turn on the printer power switch.
3. Open Diagnostic tool and set interface. (The default setting is USB.)

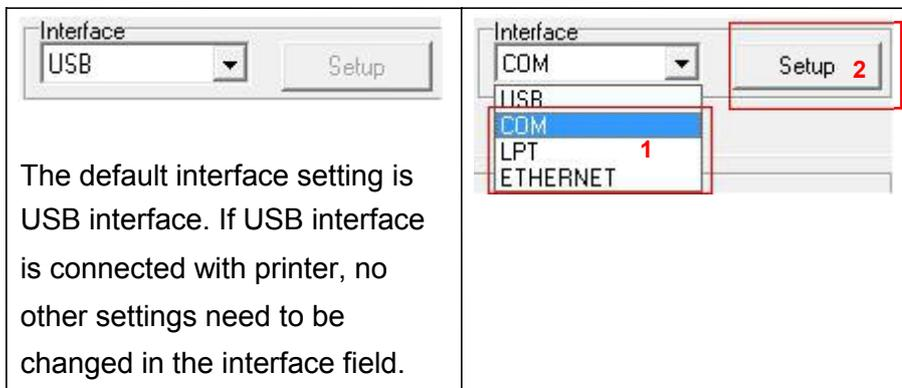

4. Click the “Calibrate Sensor” button.
5. Select the media type and click the “Calibrate” button.

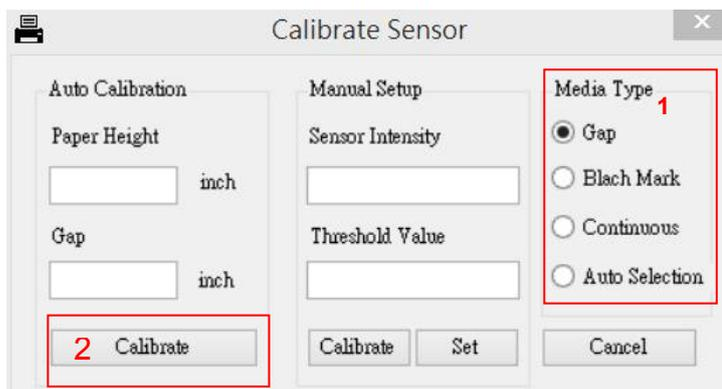

## 5.4 Setting Ethernet by Diagnostic Utility (Option)

The Diagnostic Utility is enclosed in the CD disk \Utilities directory. Users can use Diagnostic Tool to setup the Ethernet by RS-232, USB and Ethernet interfaces. The following contents will instruct users how to configure the Ethernet by these three interfaces.

### 5.4.1 Using USB interface to setup Ethernet interface

1. Connect the USB cable between the computer and the printer.
2. Turn on the printer power.
3. Start the Diagnostic Utility by double clicking on the  Diagnostic Tool.exe icon.
4. The Diagnostic Utility default interface setting is USB interface. If USB interface is connected with printer, no other settings need to be changed in the interface field.

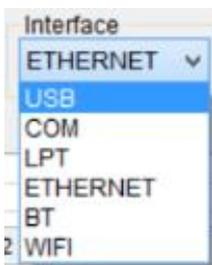

5. Click on the "Ethernet Setup" button from "Printer Function" group in Printer Configuration tab to setup the IP address, subnet mask and gateway for the on board Ethernet.

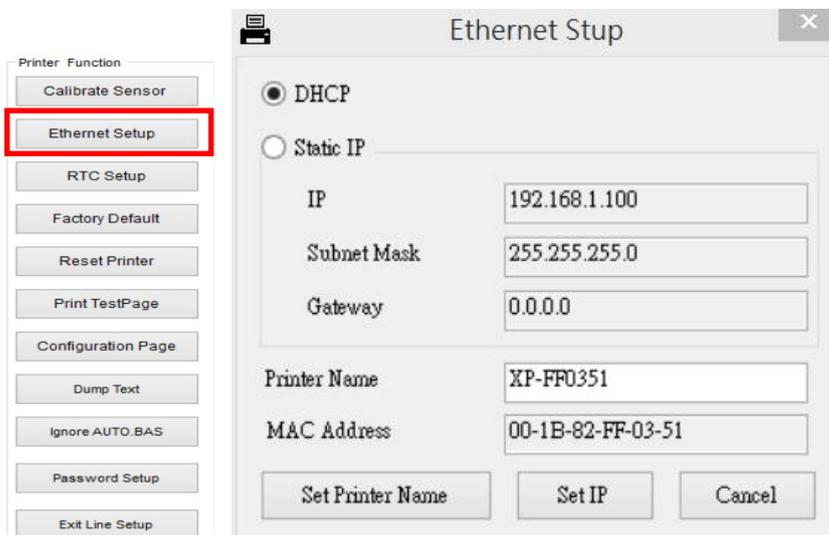

### 5.4.2 Using RS-232 interface to setup Ethernet interface

1. Connect the computer and the printer with a RS-232 cable.
2. Turn on the printer power.
3. Start the Diagnostic Utility by double clicks on the  Diagnostic Tool.exe icon.
4. Select “COM” as interface then click on the “Setup” button to setup the serial port baud rate, parity check, data bits, stop bit and flow control parameters.

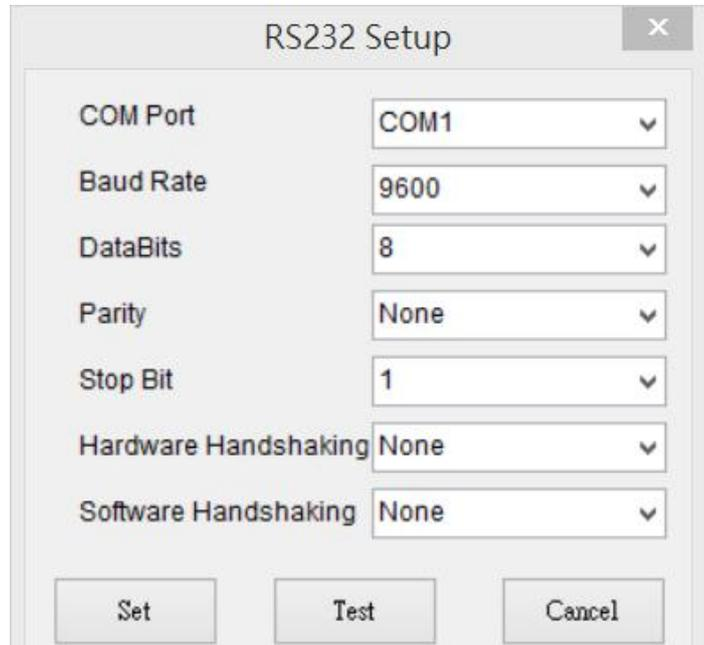
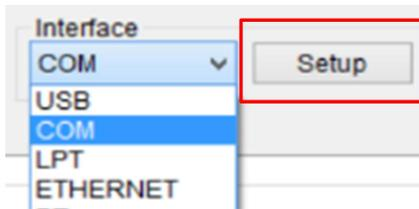

5. Click on the “Ethernet Setup” button from printer function of Printer Configuration tab to setup the IP address, subnet mask and the gateway for the on board Ethernet.

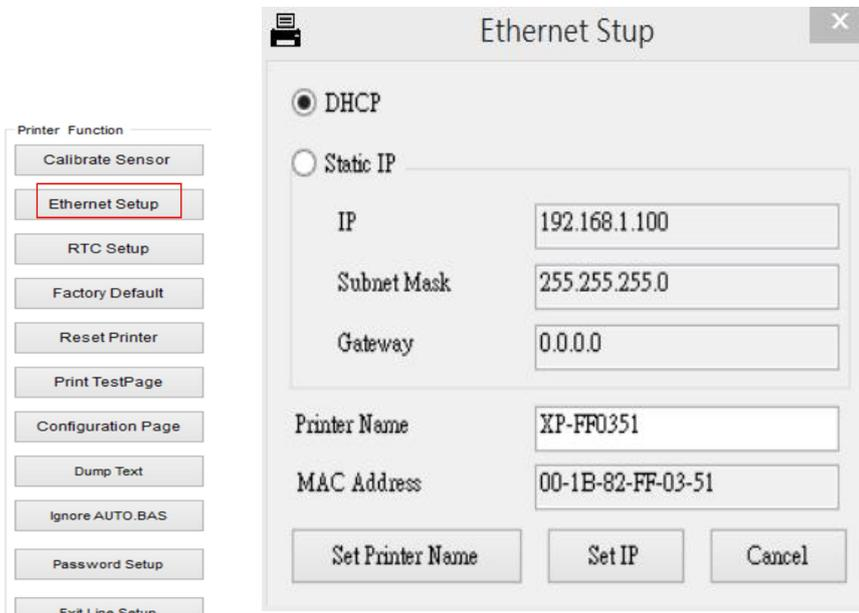

### 5.4.3 Using Ethernet interface to setup Ethernet interface

1. Connect the computer and the printer to the LAN.
2. Turn on the printer power.
3. Start the Diagnostic Utility by double clicks on the  icon.
4. Select “Ethernet” as the interface then click on the “Setup” button to setup the IP address, subnet mask and gateway for the on board Ethernet.

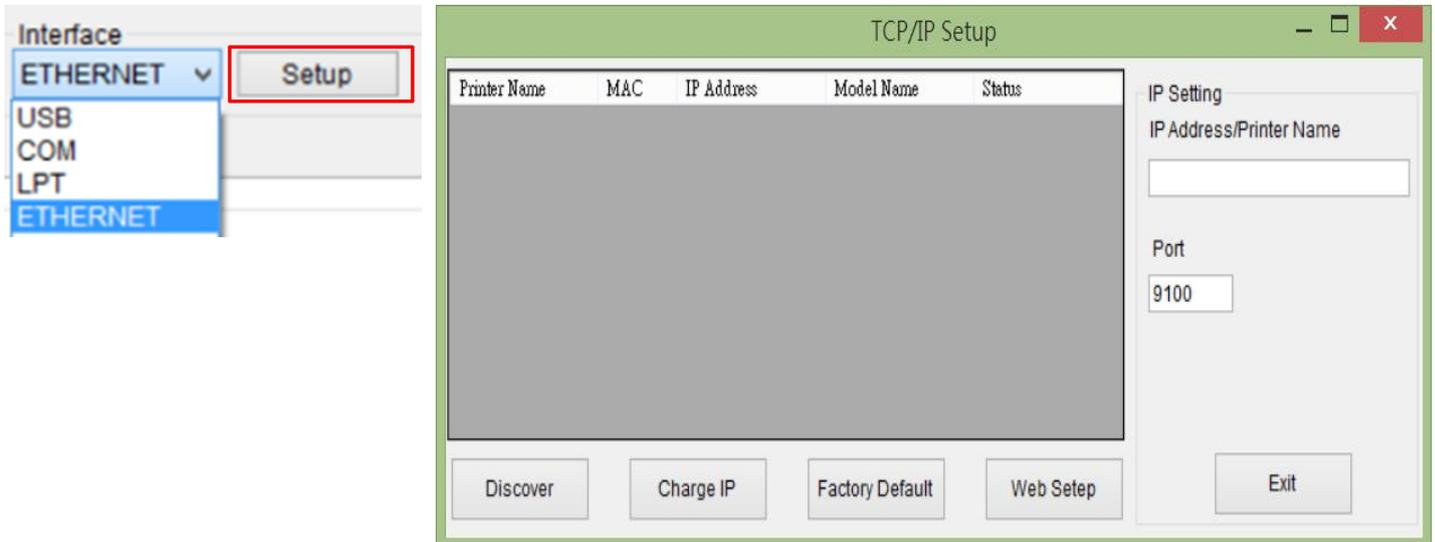

5. Click the “Discover Device” button to explore the printers that exist on the network.
6. Select the printer in the left side of listed printers, the correspondent IP address will be shown in the right side “IP address/Printer Name” field.
7. Click “Change IP Address” to configure the IP address obtained by DHCP or static.

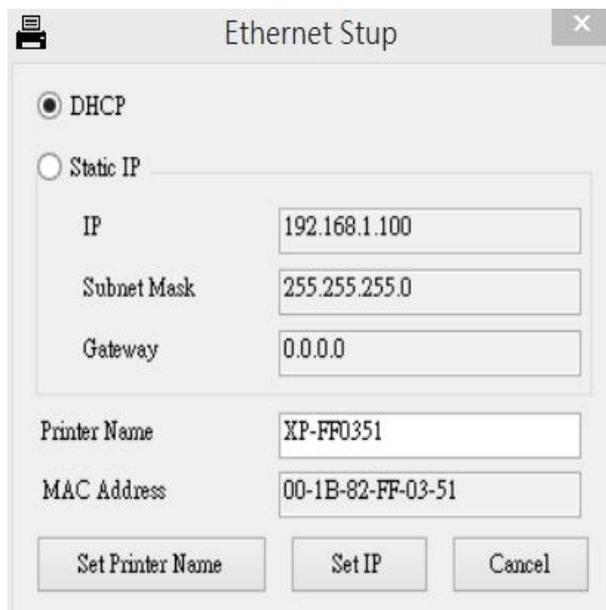

The default IP address is obtained by DHCP. To change the setting to static IP address, click “Static IP” radio button then enter the IP address, subnet mask and gateway. Click “Set IP” to take effect the settings.

Users can also change the “Printer Name” by another model name in this fields then click “Set Printer Name” to take effect this change.

***Note: After clicking the “Set Printer Name” or “Set IP” button, printer will reset to take effect the settings.***

8. Click “Exit” button to exit the Ethernet interface setup and go back to Diagnostic Tool main screen.

Factory Default button

This function will reset the IP, subnet mask, gateway parameters obtained by DHCP and reset the printer name.

Web setup button

Except to use the Diagnostic Utility to setup the printer, you can also explore and configure the printer settings and status or update the firmware with the IE or Firefox web browser. This feature provides a user friendly setup interface and the capability to manage the printer remotely over a network.

# 6. Troubleshooting

## 6.1 Common Problems

The following guide lists the most common problems that may be encountered when operating this barcode printer. If the printer still does not function after all suggested solutions have been invoked, please contact the Customer Service Department of your purchased reseller or distributor for assistance.

Problem	Possible Cause	Recovery Procedure
<b>Power indicator does not illuminate</b>	* The power cord is not properly connected.	* Plug the power cord in printer and outlet. * Switch the printer on.
- The printer status from DiagTool shows " <b>Head Open</b> ".	* The printer carriage is open.	* Please close the print carriage.
- The printer status from DiagTool shows " <b>Ribbon End Err.</b> " Or " <b>Ribbon Encoder Err.</b> " -	* Running out of ribbon. * The ribbon is installed incorrectly.	* Supply a new ribbon roll. * Please refer to the steps on section 3.2 to re-install the ribbon.
- The printer status from DiagTool shows " <b>Out of Paper</b> ".	* Running out of label. * The label is installed incorrectly. * Gap/black mark sensor is not calibrated.	* Supply a new label roll. * Please refer to the steps on section 3.3 to reinstall the label roll. * Calibrate the gap/black mark sensor.
- The printer status from DiagTool shows " <b>Paper Jam</b> ".	* Gap/black mark sensor is not set properly. * Make sure label size is set properly. * Labels may be stuck inside the printer mechanism.	* Calibrate the gap/black mark sensor. * Set label size correctly.
- " <b>Take Label</b> ".	* Peel-off function is enabled.	* If the peel-off module is installed, please remove the label. * If there is no peel-off module in front of the printer, please switch off the printer and install it. * Check if the connector is plugging correctly.

<p style="text-align: center;"><b>Not Printing</b></p>	<ul style="list-style-type: none"> <li>* Cable is not well connected to serial or USB interface or parallel port.</li> <li>* The serial port cable pin configuration is not pin to pin connected.</li> </ul>	<ul style="list-style-type: none"> <li>* Re-connect cable to interface.</li> <li>* If using serial cable, <ul style="list-style-type: none"> <li>- Please replace the cable with pin to pin connected.</li> <li>- Check the baud rate setting. The default baud rate setting of printer is 9600,n,8,1.</li> </ul> </li> <li>* If using the Ethernet cable, <ul style="list-style-type: none"> <li>- Check if the Ethernet RJ-45 connector green LED is lit on.</li> <li>- Check if the Ethernet RJ-45 connector amber LED is blinking.</li> <li>- Check if the printer gets the IP address when using DHCP mode.</li> <li>- Check if the IP address is correct when using the static IP address.</li> <li>- Wait a few seconds let the printer get the communication with the server then check the IP address setting again.</li> </ul> </li> <li>* Chang a new cable.</li> <li>* Ribbon and media are not compatible.</li> <li>* Verify the ribbon-inked side.</li> <li>* Reload the ribbon again.</li> <li>* Clean the print head.</li> <li>* The print density setting is incorrect.</li> <li>* Print head's harness connector is not well connected with printhead. Turn off the printer and plug the connector again.</li> <li>* Check your program if there is a command PRINT at the end of the file and there must have CRLF at the end of each command line.</li> </ul>
<p style="text-align: center;"><b>Memory full ( FLASH / DRAM )</b></p>	<ul style="list-style-type: none"> <li>* The space of FLASH/DRAM is full.</li> </ul>	<ul style="list-style-type: none"> <li>* Delete unused files in the FLASH/DRAM.</li> <li>* The max. numbers of DRAM is 256 files.</li> <li>* The max. user addressable memory space of DRAM is 256KB.</li> <li>* The max. numbers of file of FLASH is 256 files.</li> <li>* The max. user addressable memory space of FLASH is 2560KB.</li> </ul>
<p style="text-align: center;"><b>microSD card is unable to use</b></p>	<ul style="list-style-type: none"> <li>* microSD card is damaged.</li> <li>* microSD card doesn't insert correctly.</li> <li>* Use the non-approved microSD card manufacturer.</li> </ul>	<ul style="list-style-type: none"> <li>* Use the supported capacity microSD card.</li> <li>* Insert the microSD card again.</li> <li>* The supported microSD card spec and the approved microSD card manufacturers, please refer to section 2.2.3.</li> </ul>
<p style="text-align: center;"><b>Poor Print Quality</b></p>	<ul style="list-style-type: none"> <li>* Ribbon and media is loaded incorrectly</li> <li>* Dust or adhesive accumulation on the print head.</li> <li>* Print density is not set properly.</li> <li>* Printhead element is damaged.</li> <li>* Ribbon and media are incompatible.</li> <li>* The printhead pressure is not set properly.</li> </ul>	<ul style="list-style-type: none"> <li>* Reload the supply.</li> <li>* Clean the print head.</li> <li>* Clean the platen roller.</li> <li>* Adjust the print density and print speed.</li> <li>* Run printer self-test and check the print head test pattern if there is dot missing in the pattern.</li> <li>* Change proper ribbon or proper label media.</li> <li>* The print head mechanism does not latch the print head properly.</li> </ul>
<p style="text-align: center;"><b>Cutter is not working</b></p>	<ul style="list-style-type: none"> <li>* The connector is loose.</li> <li>* Cutter jam.</li> <li>* Cutter PCB is damaged.</li> </ul>	<ul style="list-style-type: none"> <li>* Plug in the connect cable correctly.</li> <li>* Remove the label.</li> <li>* Make sure the thickness of label is less than 0.19 mm.</li> <li>* Replace a cutter driver IC board.</li> </ul>

<b>Skip labels when printing</b>	<ul style="list-style-type: none"> <li>* Label size is not specified properly.</li> <li>* Sensor sensitivity is not set properly.</li> <li>* The media sensor is covered with dust.</li> </ul>	<ul style="list-style-type: none"> <li>* Check if label size is setup correctly.</li> <li>* Calibrate the sensor by Auto Gap or Manual Gap options.</li> <li>* Clear the GAP/Black mark sensor by blower.</li> </ul>
<b>The printing position of small label is incorrect</b>	<ul style="list-style-type: none"> <li>* Media sensor sensitivity is not set properly.</li> <li>* Label size is incorrect.</li> <li>* The parameter Shift Y in the</li> <li>* The vertical offset setting in the driver is incorrect.</li> </ul>	<ul style="list-style-type: none"> <li>* Calibrate the sensor sensitivity again.</li> <li>* Set the correct label size and gap size.</li> <li>* If using the software BarTender, please set the vertical offset in the driver.</li> </ul>
<b>Missing printing on the left or right side of label</b>	<ul style="list-style-type: none"> <li>* Wrong label size setup.</li> </ul>	<ul style="list-style-type: none"> <li>* Set the correct label size.</li> </ul>
<b>RTC time is incorrect when reboot the printer</b>	<ul style="list-style-type: none"> <li>* The battery has run down.</li> </ul>	<ul style="list-style-type: none"> <li>* Check if there is a battery on the main board.</li> </ul>
<b>Wrinkle problem</b>	<ul style="list-style-type: none"> <li>* Ribbon installation is incorrect.</li> <li>* Media installation is incorrect.</li> <li>* Print density is incorrect.</li> <li>* Media feeding is incorrect.</li> </ul>	<ul style="list-style-type: none"> <li>* Please set the suitable density to have good print quality.</li> <li>* Make sure the label guide touch the edge of the media guide.</li> </ul>
<b>Gray line on the blank label</b>	<ul style="list-style-type: none"> <li>* The print head is dirty.</li> <li>* The platen roller is dirty.</li> </ul>	<ul style="list-style-type: none"> <li>* Clean the print head.</li> <li>* Clean the platen roller.</li> </ul>
<b>Irregular printing</b>	<ul style="list-style-type: none"> <li>* The printer is in Hex Dump mode.</li> <li>* The RS-232 setting is incorrect.</li> </ul>	<ul style="list-style-type: none"> <li>* Turn off and on the printer to skip the dump mode.</li> <li>* Re-set the Rs-232 setting.</li> </ul>

# 7. Maintenance

This session presents the clean tools and methods to maintain your printer.

1. Please use one of following material to clean the printer.

- Cotton swab
- Lint-free cloth
- Vacuum / Blower brush
- 100% ethanol

2. The cleaning process is described as following,

Printer Part	Method	Interval
Print Head	1. Always turn off the printer before cleaning the print head. 2. Allow the print head to cool for a minimum of one minute. 3. Use a cotton swab and 100% ethanol to clean the print head surface.	Clean the print head when changing a new label roll
		
Platen Roller	1. Turn the power off. 2. Rotate the platen roller and wipe it thoroughly with 100% ethanol and a cotton swab, or lint-free cloth.	Clean the platen roller when changing a new label roll
Tear Bar/Peel Bar	Use the lint-free cloth with 100% ethanol to wipe it.	As needed
Sensor	Compressed air or vacuum	Monthly
Exterior	Wipe it with water-dampened cloth	As needed
Interior	Brush or vacuum	As needed

**Note:**

- Do not touch printer head by hand. If you touch it careless, please use ethanol to clean it.
- Please use 100% Ethenol. DO NOT use medical alcohol, which may damage the printer head.
- Regularly clean the print head and supply sensors once change a new ribbon to keep printer performance and extend printer life.

# Revise History

Date	Content	Editor
2016/12/25	*Release V1.00	Austin Bill



Xprinter® 芯烨  
XINYE

Corporate Headquarters

4th Floor, 2 Building, No.639 Huayu Road,  
Qianshan Industrial Park, Xiangzhou District,  
Zhuhai City, Guangdong Province, China.  
TEL: +86-4006-139-828

Website: [www.xprinter.net](http://www.xprinter.net)

Zhuhai Hengquan Barcode equipment  
Co., Ltd.